

LECTURE 11: MATHEMATICAL MODEL

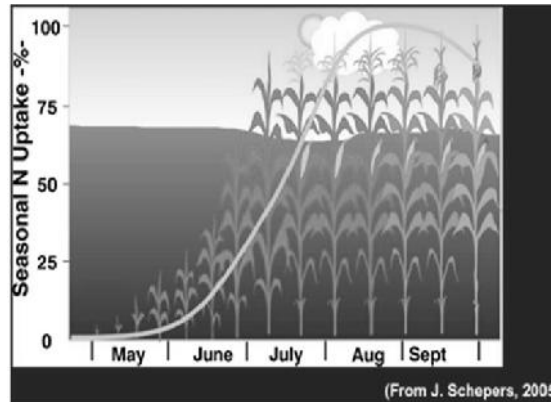

The essence of mathematics is not to make simple things complicated, but to make complicated things simple. ~S. Gudder

LECTURE OUTCOMES

After mastering the lecture materials at the end of the lecture, students should be able

1. to develop mathematical, mechanistic models based on assumptions on the biological process of biomass production of plants
2. to explain possible, biological processes in the biomass production of plants

LECTURE OUTLINE

1. INTRODUCTION

- Conceptual Model Approach
- Mechanistic Approach

2. BIOMASS PRODUCTION MODELS

- Assumption 1: The rate of biomass production is constant
- Assumption 2: The rate of biomass production is dependent upon the growth machinery
- Assumption 3: The rate of biomass production is dependent upon the substrate
- Assumption 4: The rate of biomass production is dependent upon the growth machinery and the substrate

INTRODUCTION

WHY DO WE NEED MODELS?

1. A model is a simplification of a system
2. A system is very complex and not easy to study
3. The application of model to study a complex system such as plant growth is one of approaches
4. Therefore, it is very important to develop a good model of a system, a model that could simulate the behavior of the system under consideration

| | | | x | y |
|----|---|---|-----|----------|
| | A | B | A/B | α |
| 1 | | | | |
| 2 | | | | |
| 3 | | | | |
| 4 | | | | |
| 5 | | | | |
| 6 | | | | |
| 7 | | | | |
| 8 | | | | |
| 9 | | | | |
| 10 | | | | |



Hibiscus syriacus
Rose-of-Sharon

α

What is the best model for this relationship, what is your assumption

A/B

• Conceptual Model Approach

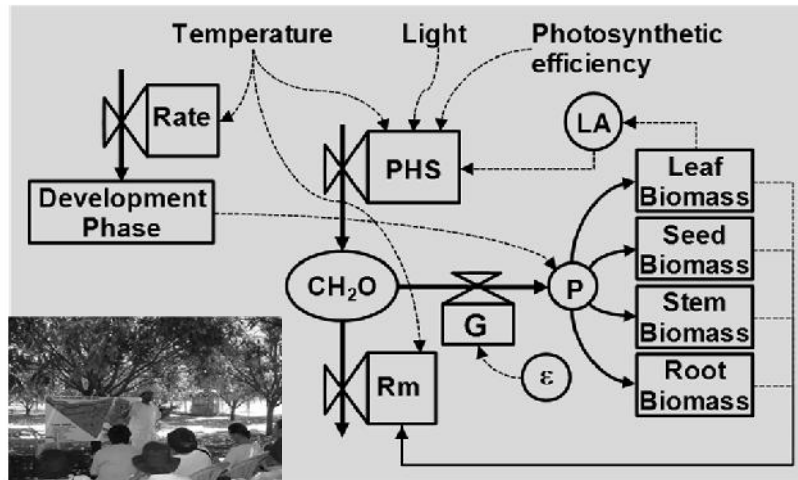

How things happen: What are The Factors determining The Biomass Production ?,.. *Make it simple, not too complicated*

- Mechanistic Approach

$$\begin{aligned}
 &\text{BIOMASS PRODUCTION} \\
 &= \\
 &\text{Productivity per unit time} \\
 &\times \\
 &\text{Growing period} \\
 &= \\
 &\partial W / \partial t \times T
 \end{aligned}$$

$\partial W / \partial t$ = Productivity per unit time
 T = Growing period

The main key for the analysis is

$\partial W / \partial t$ → the amount of water (δw)
 falls per unit time (δt)

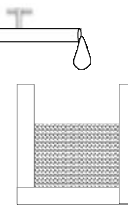

What is $\partial W / \partial t$ dependent on ?

1. Is $\partial W / \partial t$ constant with time, not dependent on anything (any factor) ?
2. Is $\partial W / \partial t$ dependent upon something ?
What ?

3. A student analyzed his/her data following his/her friends method
4. Unfortunately, the results of analysis were not clearly understood by the students (what the results did mean)
5. Empirical Approach = the data collected and analyzed directly to get the insight of plant system reflected by the results of analysis
6. Mechanistic Approach = the behavior of plant system in a particular environment is analyzed first, then data were collected to test the results of analysis (hypothesis)

A simple example of mechanistic models: Water flow from a base aperture

A Outlet velocity ($\text{m}\cdot\text{s}^{-1}$) can be expressed as

$$v = C_v (2 g H)^{1/2}$$

where

C_v = velocity coefficient (water 0.97)
 g = acceleration of gravity (9.81 m/s^2)
 H = height (m)

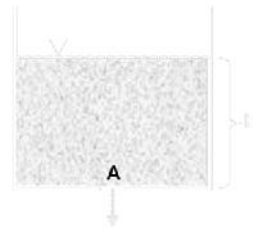

Volume flow ($\text{m}^3\cdot\text{s}^{-1}$) can be expressed as

$$V = C_d A (2 g H)^{1/2} \quad (1b)$$

C_d = discharge coefficient ($C_d = C_c C_v$)

where

C_c = contraction coefficient (sharp edge aperture 0.62, well rounded aperture 0.97)
 A = area aperture (m^2)

BIOMASS PRODUCTION MODELS

1. The system of plants in the production of biomass (dry weight) can be simplified by two processes;
 - i. Photosynthetic process that converts CO_2 into sugars (simple carbohydrates) using the energy of solar radiation in natural condition
 - ii. Metabolic processes that convert sugars into various molecules (plant biomass)

2. Growth can be defined as the biochemical conversion of reserve substances into structural dry matter (Penning de Vries et al., 1989)
3. Structural dry matter consists of the organic components that remain at the end of the plant's life, that is, are not normally broken down.
4. In contrast, 'reserves' are components that only exist temporarily and are used for maintenance or growth within hours or days (available reserves) or after a few weeks (shielded reserves).

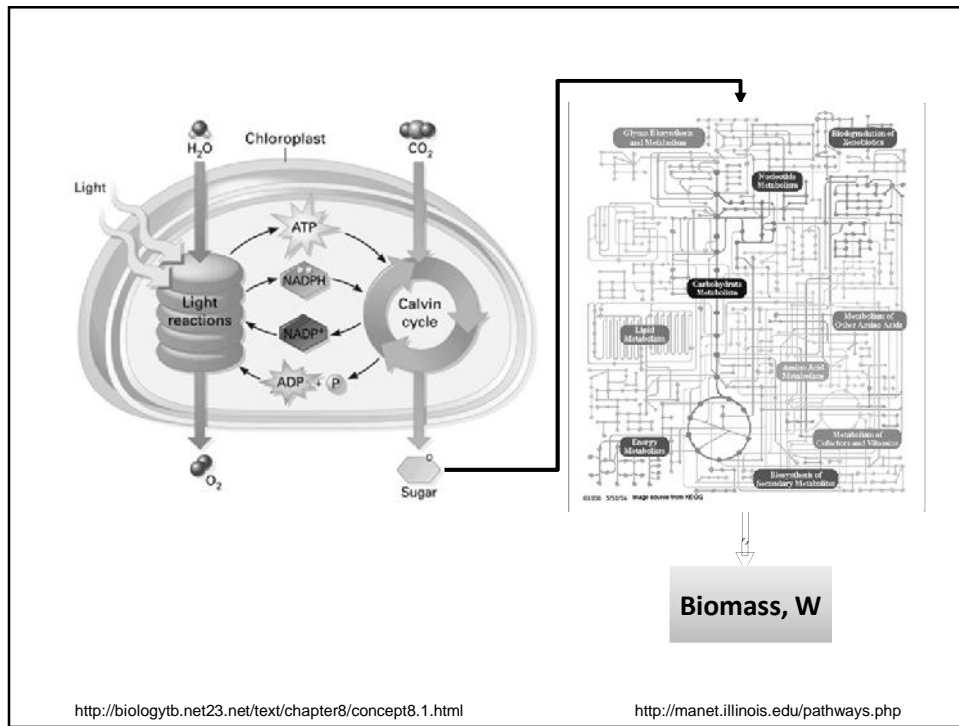

5. The production of biomass can be simplified to be

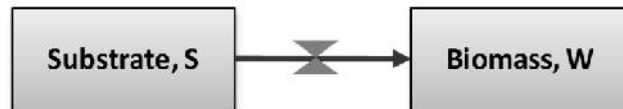

6. We may assume that a plant is a factory using machines to process substrates to produce particular product (W)



ASSUMPTION 1

- If it is assumed that the production of biomass is not limited by the capacity of machine and the quantity of substrate, then

$$\delta W / \delta t = \text{constant}$$

$$\delta W / \delta t = k$$

where k = a constant value



$$\int_{W_0}^W \delta W = k \int_0^t \delta t \longrightarrow W - W_0 = k(t - 0)$$

$$\mathbf{W = W_0 + kt}$$

Apply the model to data

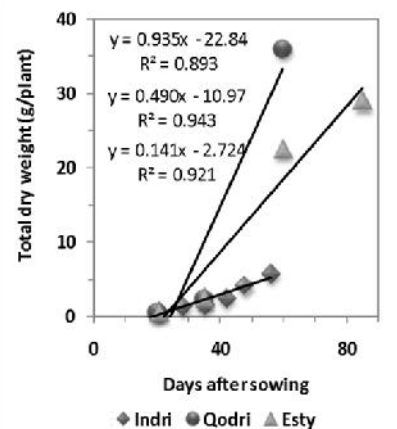
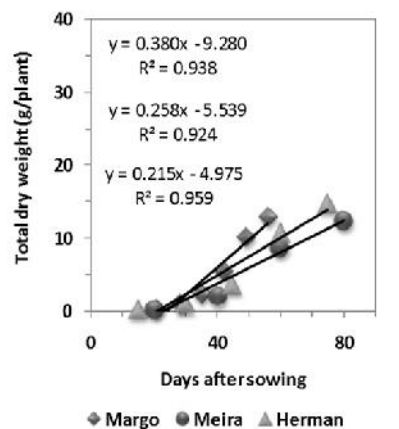

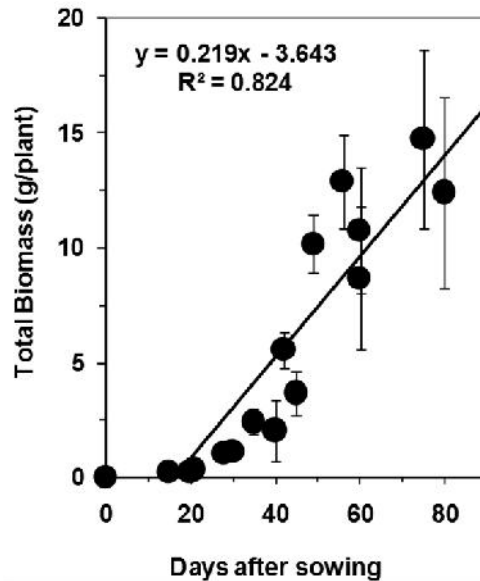

Is this right ?

Discussion

- Is the model good enough to describe the growth of plant under consideration?
- Is the assumption used sound biologically?
 - *The production of biomass per unit time (day) is constant for the entire life of plants?*

Kesimpulan

1. Aplikasi dari pers dengan Asumsi 1 menghasilkan suatu koefisien korelasi yang cukup tinggi, sehingga model dari segi statistik cukup baik untuk menggambarkan hubungan antara biomassa tanaman dengan umur.
2. Dari segi biologis dan kenyataan di lapangan, model tersebut tidak cukup baik untuk menggambarkan keadaan yang sesungguhnya.

ASSUMPTION 2

1. A growing plant from molecular to plant level performs the characteristic of **autocatalytic system (self-reproduction) which uses its products for its own formation.**
 - Molecular level. The photosynthetic carbon reduction (PCR) or Benson-Calvin cycle is autocatalytic with regeneration of the CO₂ acceptor (Ribulose 1,5 bisphosphate).
 - Cellular level. New cells are produced from the existing cell by cell devition
 - Organ level. An increase in leaf are, determining the quantity of light interception and carbohydrate production, is dependent on the supply of carbohydrate for leaf formation.

2. The autocatalytic system of plants leads to the notion that the machinery of plants producing biomass is the plants themselves.
3. If total dry weight (**W**) is proportional to leaves, roots and metabolic capacity, then it may be assumed that
 - the quantity of growth machinery is proportional to dry weight (**W**),
 - the growth machinery works at a maximal rate so long as there is any substrate available at all
 - growth is irreversible and stops once the substrate is exhausted

4. With the assumptions, the growth of plants (dry weight increase) is dependent upon the initial magnitude of **W** (growth machinery), so that
 - The conversion of substrate to biomass is controlled by the present total biomass (**W**)

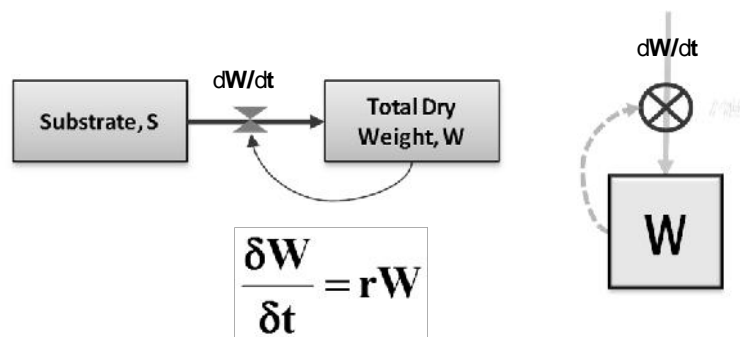

- The form of equation to describe the phenomenon is

$$\frac{\delta W}{\delta t} = rW$$

where δW is an increase in plant biomass, δt is an increase in time (day or week), w = plant biomass, and r = specific growth rate or relative growth rate (RGR) as

- The integration of the differential equation gives

$$\int_{w_0}^{w_t} \frac{\delta W}{W} = r \int_0^t \delta t$$

$$\ln\left(\frac{W_t}{W_0}\right) = rt$$

$$W_t = W_0 e^{rt}$$

- This an exponential equation

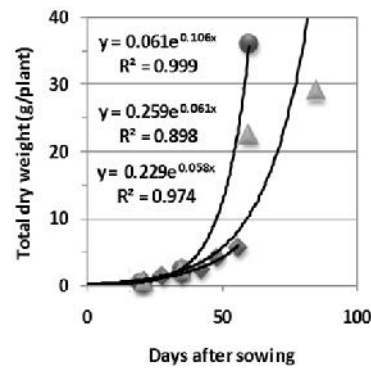
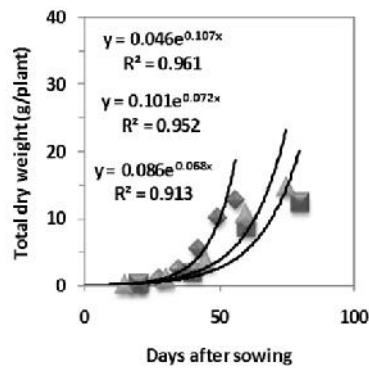

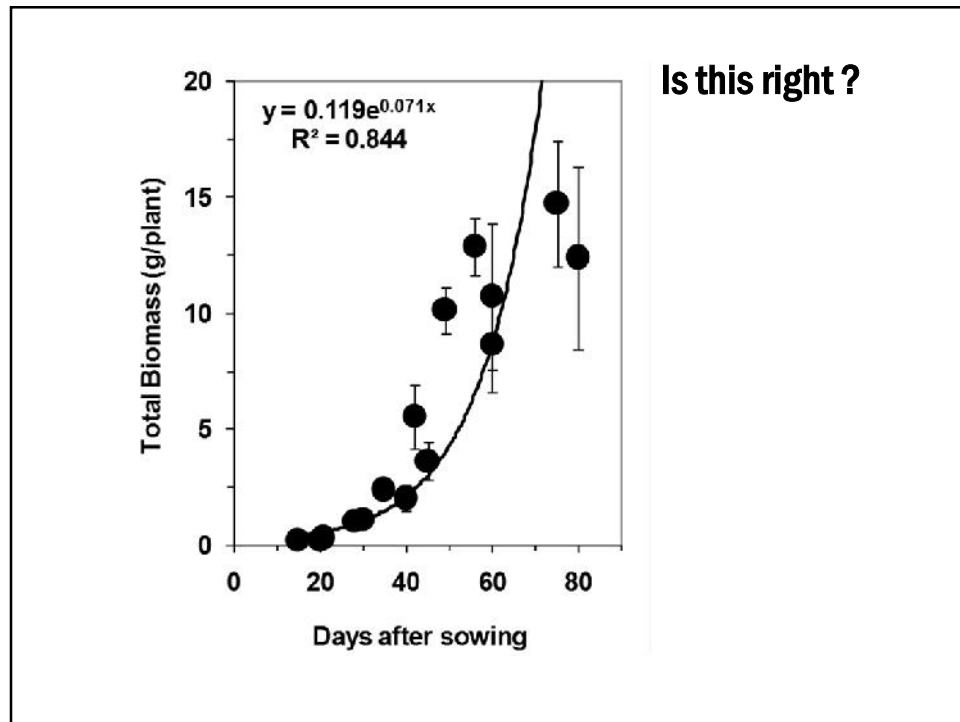

Kesimpulan

- Aplikasi dari pers dengan Asumsi 2 menghasilkan suatu koefisien korelasi yang cukup tinggi .
- Model ini cukup baik menggambarkan keadaan awal pertumbuhan tanaman hingga umur tertentu (mis. 40 hst), tetapi tidak untuk masa pertumbuhan berikutnya.

Assumption 3

- It may be assumed that
 1. the quantity of growth machinery is constant and independent of dry weight (W),
 2. the growth machinery works at a rate proportional to the substrate level (S)
 3. growth is irreversible
- With the assumptions, the growth of plants (dry weight increase) is dependent upon substrate level (S), so that

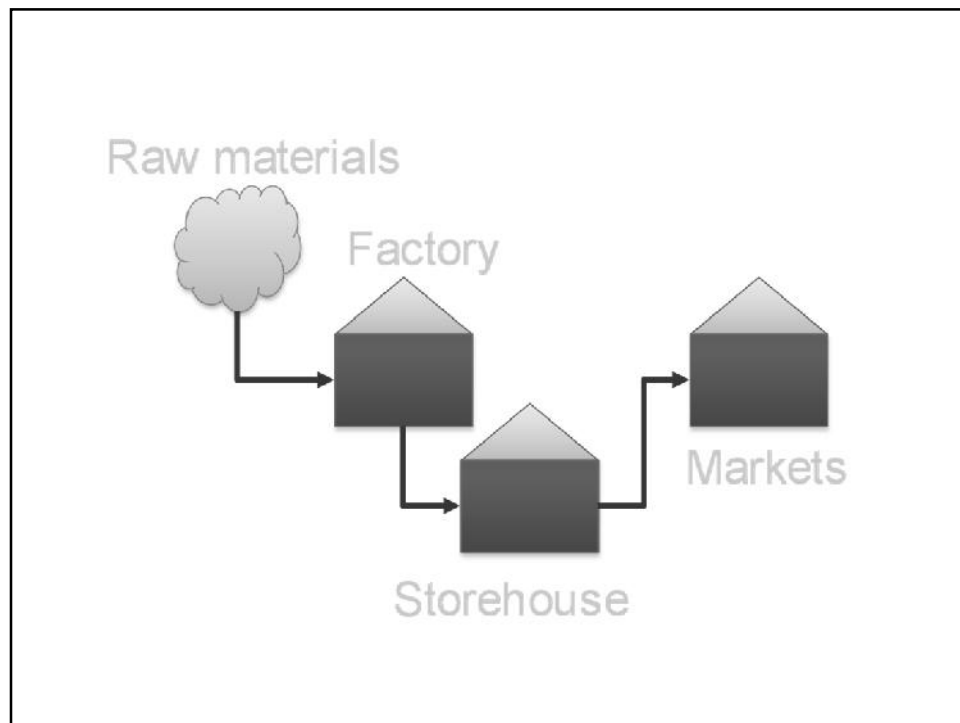

$$\frac{\delta W}{\delta t} = kS$$

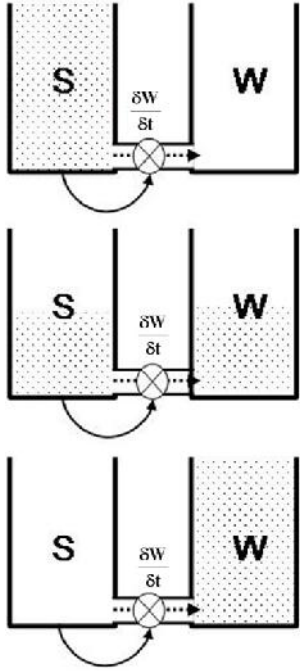

where k is constant

- The assumptions defines plants as systems that convert substrate (**S**) to plant biomass (**W**) as illustrated in the figure.

- With the assumption that there is no gain or loss of material from the system, therefore

$$\frac{\delta W}{\delta t} = -\frac{\delta S}{\delta t} \quad \text{or} \quad \frac{\delta W}{\delta t} + \frac{\delta S}{\delta t} = 0$$

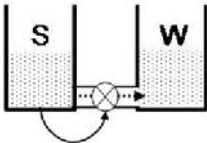

- $W+S = \text{a constant} = W_0+S_0 = W_f + S_f = C$
- W_0 and S_0 are the initial values of W and S at time $t = 0$; W_f and S_f are the final values of W and S approached $t \rightarrow \infty$ (assuming that a steady state is eventually reached); C is a constant.

- With the assumption of $W+S = W_0+S_0 = W_f + S_f$, then at the final stage

$$S_f = 0 \rightarrow W+S = W_f + 0$$

so that

$$S = W_f - W.$$

- In other words, the quantity of substrate available converted to plant biomass at any time is proportional to a difference between the final dry weight and the dry weight that has been reached. This substitutes S in the above equation which gives

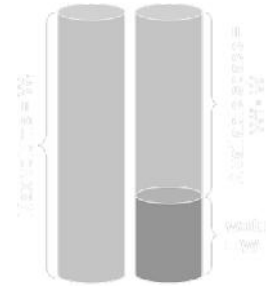

$$\frac{\delta W}{\delta t} = k(W_f - W)$$

- The integration of the above equation gives

$$\int_{W_0}^W \frac{\delta W}{W_f - W} = k \int_0^t \delta t$$

$$\ln \left(\frac{W_f - W_0}{W_f - W} \right) = kt$$

$$(W_f - W_0) = (W_f - W)e^{kt}$$

$$W_f - W = (W_f - W_0)e^{-kt}$$

$$W = W_f - (W_f - W_0)e^{-kt}$$

- If the initial dry weight $W_0 = 0$, then

$$W = W_f - W_f e^{-kt}$$

or

$$W = W_f (1 - e^{-kt})$$

$$W = W_{\max} (1 - e^{-kt})$$

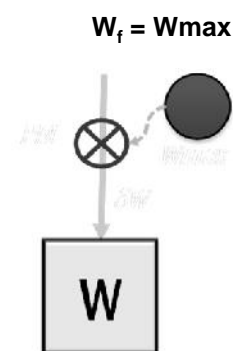

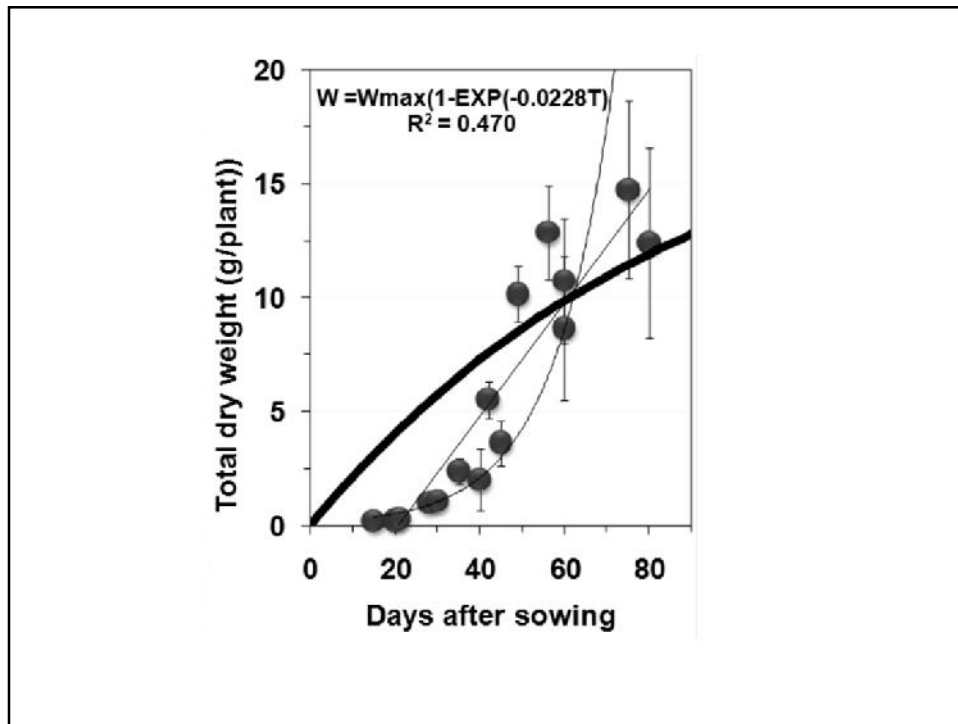

Kesimpulan

- Aplikasi dari pers (6b) pada data yang sama dengan yang disajikan pada Gambar 7 menghasilkan suatu koefisien korelasi yang rendah
- Jadi secara statistik, model tersebut tidak cukup baik untuk menggambarkan perkembangan biomassa tanaman dengan waktu, sekalipun dapat meliputi sebaran data pada bagian akhir pertumbuhan tanaman.

- Dengan demikian, produksi biomassa tanaman secara umum tidak berhubungan dengan kapasitas aktual tanaman (perbedaan kapasitas maksimum dengan kapasitas yang sudah dipakai) untuk menampung produk biomassa.
- Sekalipun asumsi ini cukup logis secara fisik tetapi tidak secara dinamika pertumbuhan tanaman karena kapasitas yang belum terpakai pada awal pertumbuhan besar yang tidak akan membuat produksi biomassa tanaman yang besar.

- Ini didasarkan atas kenyataan bahwa kuantitas organ fotosintesis (daun), yang berkembang dengan waktu, sangat rendah pada awal pertumbuhan.
- Pengaruh dari kapasitas tanaman yang belum terpakai untuk menampung produk biomassa dapat nyata pada bagian akhir pertumbuhan
- Kapasitas yang belum terpakai pada bagian akhir pertumbuhan pada sebagian tanaman didominasi oleh bagian generatif seperti biji

Assumption 4.

- Hasil analisis diatas mengisyaratkan kombinasi asumsi 2 dan 3 mungkin dapat menghasilkan model pertumbuhan yang dapat menjelaskan kinerja sistem tanaman dalam produksi biomassa.
- Jadi produksi biomassa tanaman ditentukan oleh kapasitas mesin dan kapasitas tanaman yang tersedia untuk menampung produksi biomassa tersebut.

- Model dari sistem tanaman dalam bentuk diagram alir sama dengan Gambar sebelumnya dan model dalam bentuk persamaan matematis adalah

$$\frac{\delta W}{\delta t} = rWS$$

$$\frac{\delta W}{\delta t} = rW(W_{\max} - W)$$

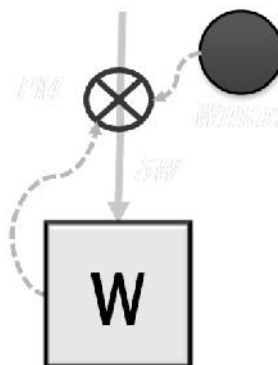

$$\frac{\delta W}{\delta t} = rW \cdot W_{\max} - \frac{rW \cdot W \cdot W_{\max}}{W_{\max}}$$

If $r \cdot W_{\max} = \mu$ then

$$\frac{\delta W}{\delta t} = \mu W (1 - W / W_{\max})$$

- Integrasi persamaan diatas dapat dilakukan lebih mudah dengan cara parsial setelah pengaturan persamaan seperti berikut.

$$\frac{\delta W}{W(1 - W / W_{\max})} = \mu \delta t$$

$$\left(\frac{1}{W(W_{\max} - W) / W_{\max}} \right) \delta W = \mu \delta t$$

$$\left(\frac{W_{\max}}{W(W_{\max} - W)} \right) \delta W = \mu \delta t$$

$$\left(\frac{1}{W_{\max} - W} + \frac{1}{W} \right) \delta W = \mu \delta t$$

- Integrasi dari persamaan diatas akan menghasilkan suatu persamaan yang dikenal dengan persamaan logistik

$$\int_{w_0}^{w_t} \left(\frac{1}{W_{\max} - W} + \frac{1}{W} \right) \delta W = \mu \int_0^t \delta t$$

$$W = \frac{W_0 W_{\max} e^{ut}}{W_{\max} - W_0 + W_0 e^{ut}}$$

atau

$$W = \frac{W_0 W_{\max}}{W_0 + (W_{\max} - W_0) e^{-ut}}$$

- Pembagian pembilang dan penyebut dari ruas kanan pers (7) dengan W_0 akan menghasilkan

$$W = \frac{W_{\max}}{1 + \left(\frac{W_{\max} - W_0}{W_0} \right) e^{-ut}}$$

$$W = \frac{W_{\max}}{1 + a \cdot e^{-ut}}$$

dimana $a = (W_{\max} - W_0)/W_0$.

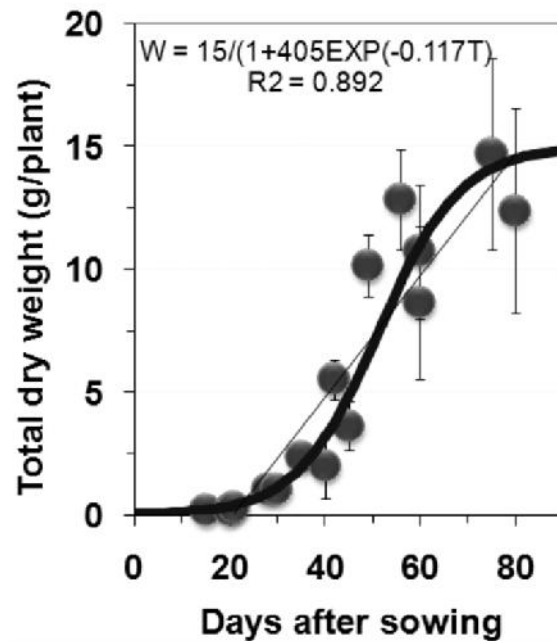

Kesimpulan

- 1. Aplikasi dari pers (8) menghasilkan suatu koefisien korelasi yang tinggi**
- 2. Jadi secara statistik dan biologis, model logistik merupakan yang paling baik untuk menggambarkan kinerja dari sistem tanaman dalam pertumbuhan untuk menghasilkan biomassa.**
- 3. Dengan demikian kinerja sistem tanaman dalam biomassa total tanaman dikendalikan oleh kemampuan mesin pertumbuhan dalam menghasilkan biomassa (fotosintesis dan metabolisme) dan kapasitas total lubang (sink) tanaman untuk menampung produksi biomassa.**
- 4. Kapasitas total lubang (sink) tanaman yang tersedia untuk menampung biomassa pada Gambar 12 adalah 405 kali dari biomassa awal (W_0) yang menggambarkan potensi tanaman pada lingkungan tertentu.**

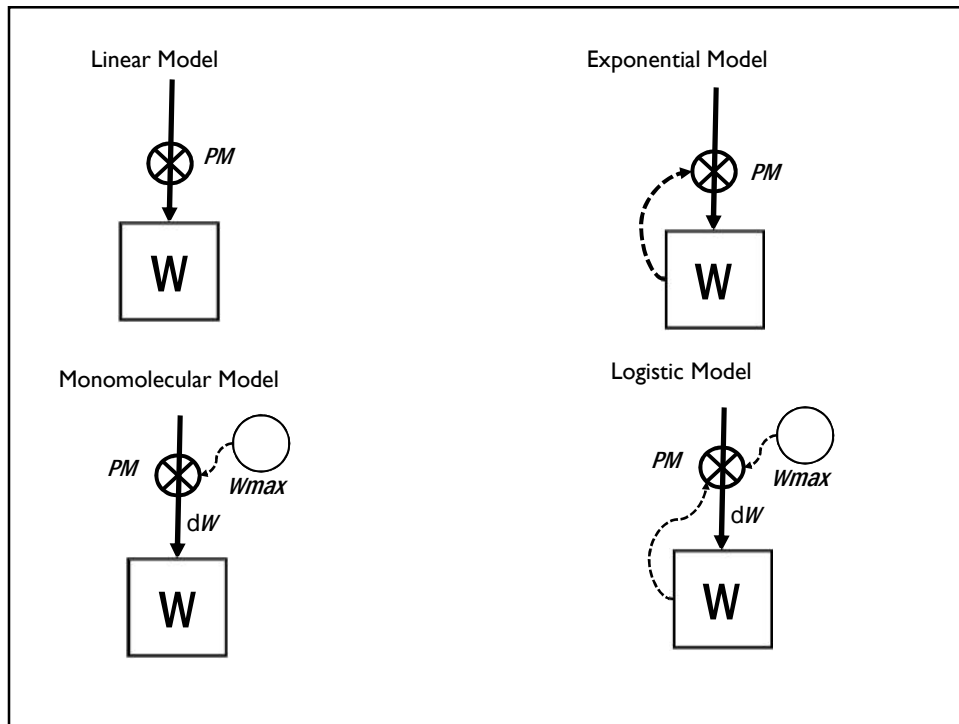

SUMMARY

1. Linear Model
$$W = W_0 + kt$$
2. Exponential Model
$$W_t = W_0 e^{rt}$$
3. Monomolecular Model
$$W_t = W_{\max} (1 - e^{-rt})$$
4. Logistic Model
$$W = \frac{W_{\max}}{1 + a \cdot e^{-ut}}$$
5. Others?

